

Overview

This Quick Reference Guide is for reference and refresh only and is not intended as a substitute for the User Guide that came with your SonoSite X-Porte system. For detailed procedures, descriptions, features, and safety precautions, see the SonoSite X-Porte User Guide, available at www.sonosite.com.

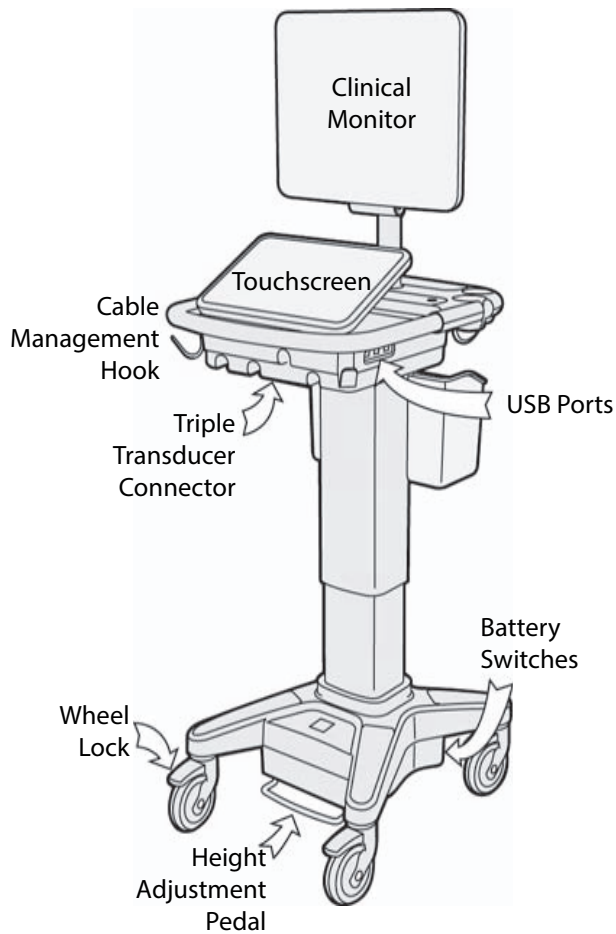

Touchscreen control panel example:

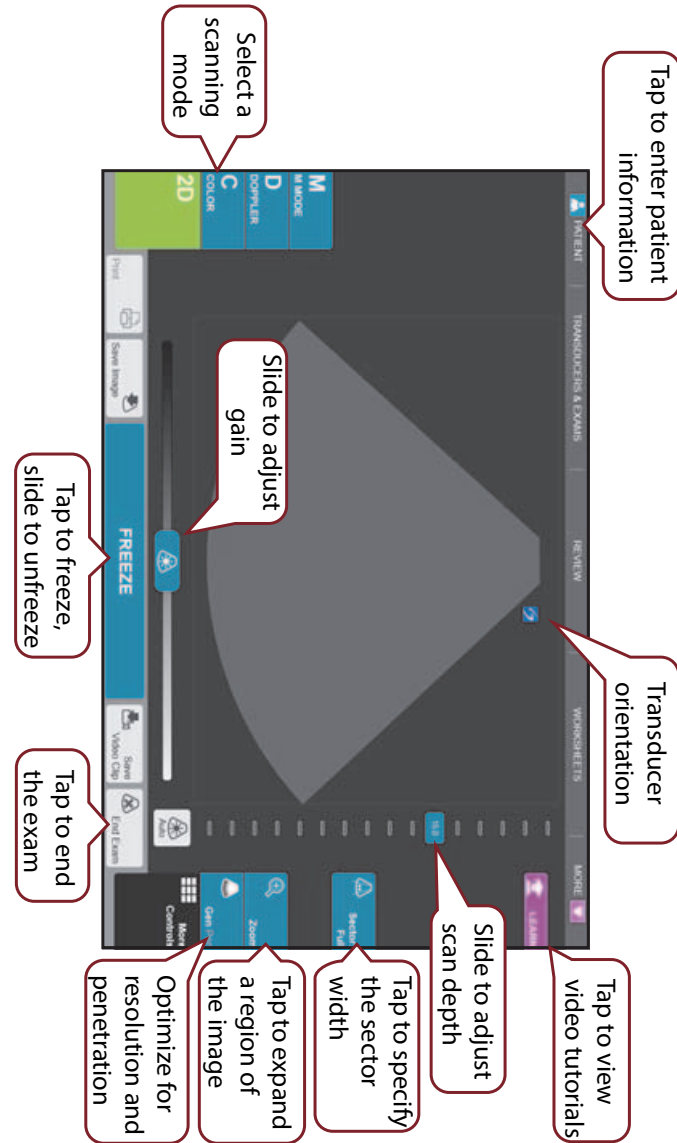

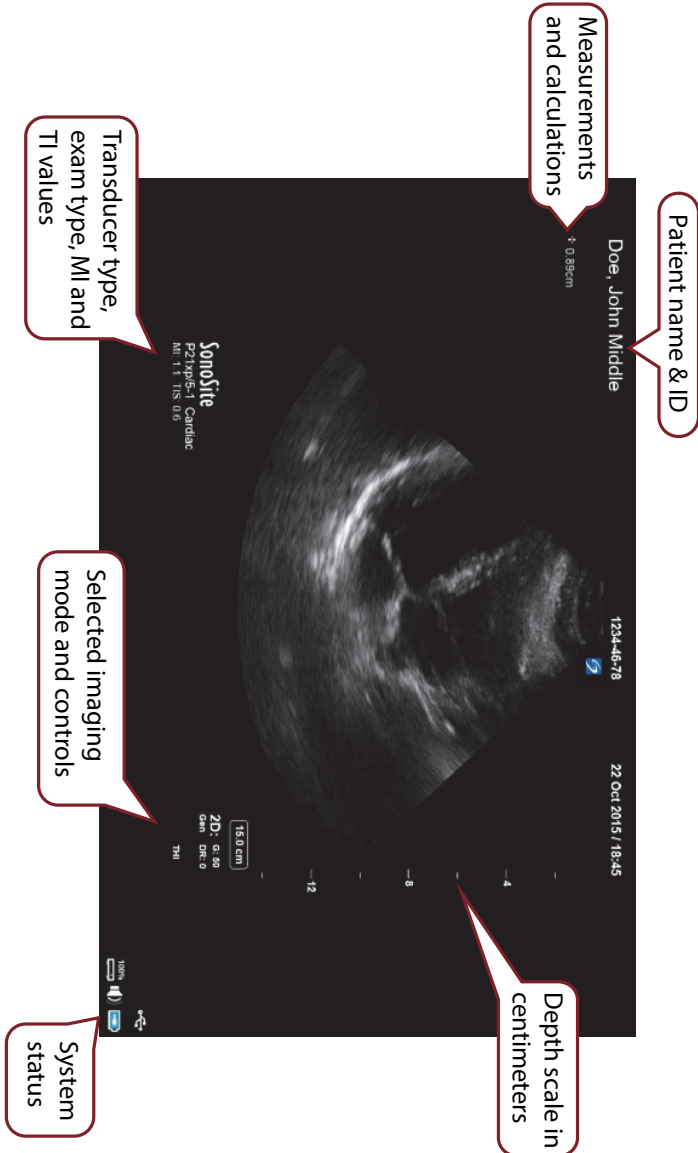

Clinical monitor example:

Before Scanning

If a control you need does not appear on the screen, tap **More Controls** to bring up a menu of controls. If you want, you can then drag controls to empty slots on the right side so they appear on the main screen.



Connecting Transducers

- 1 On the transducer connector, pull the latch up, and rotate it clockwise.
- 2 Firmly seat the connector into the port on the bottom of the unit.
- 3 Turn the latch handle counterclockwise.
- 4 Secure the connector to the system by pressing the latch up.

Checking the battery charge

- Icons in the system status area on the clinical monitor show the power and battery status.
- The system beeps to warn you that battery charge is below 14%.

Scanning

Simple scan

- 1 On startup, tap **Scan using default transducer and exam.**
- 2 To end the exam, tap **End Exam.**

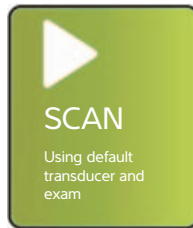

Patient-specific scan

- 1 On startup, tap **Enter patient info.**
- 2 Using the on-screen keyboard, enter the relevant patient information, and tap **Done.**

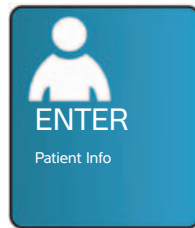

Imaging modes

- **2D** (Default) – Basic 2D scanning mode
- **M Mode** – Displays motion within the 2D image. Commonly used to measure structures in the heart.
- **Color** – The area within the box displays blood flow in color. Commonly used to show the presence and direction of blood flow.
- **Doppler** – Displays a spectrum of flow velocities over time. Commonly used to display any type of motion, including blood flow and tissue movement.

Scanning

Exam types

- 1 On startup, tap **Select Transducer and Exam.**
- 2 Under the transducer that you want to use, tap the type of exam that you want to conduct, and then tap **Scan.**

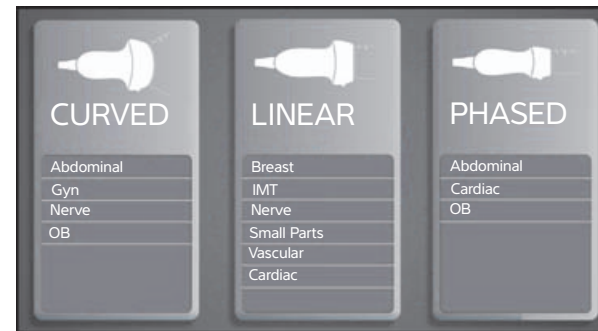
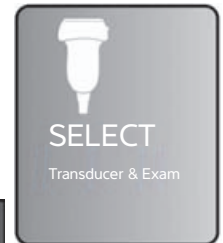

Record to DVR port

- 1 Insert a USB memory stick in the DVR port.
- 2 Tap  **Rec** .
- 3 Tap **Rec** again to stop recording.

Label an image

- 1 Tap **Label**, and either enter text at the top of the form, or choose a standard label from the list. You can also tap **Picto** to choose from a list of graphic labels.
- 2 Tap **Done** and then drag the label to the desired location on the image.

Tips on using the touchscreen interface

Gestures

- **Swipe** – Scroll pages and images; steer the D-line and the color box.
- **Drag** – Change depth; adjust gain; move buttons, calipers, and labels.
- **Tap** – Select modes, screens, and tools.
- **Pinch & spread** – Using two fingers, zoom in or expand an image or a Color Doppler scan.

Freezing and unfreezing

Using two fingers, tap the screen twice quickly.

Gain and depth

Adjust gain and depth by dragging the associated sliders.

Zoom

- 1 Tap **Zoom**.
- 2 Drag the zoom box to a location on the screen.
- 3 Using two fingers, pinch or spread the zoom box to the desired size.
- 4 Double-tap the zoom box to expand the selected area.

Measuring

Measuring distance

- 1 On a frozen image, tap **Distance**.
- 2 Drag the caliper to the first point.
- 3 Drag the second caliper to the second point.

Measuring heart rate

- 1 On a frozen M Mode or scrolling Doppler trace, tap **Heart Rate**.
- 2 Drag the caliper to the peak of the heartbeat.
- 3 Drag the second caliper to the peak of the next heartbeat.

Displaying calculations

- To display a list of calculations, tap **Calcs**.
- To display a list of acute care calculations, tap **Acute Care**.

Managing images and clips

Reviewing

Tap **Review** to see the images and clips in the current exam, or tap **Patient List** to view a different exam.

Labeling

- 1 Tap **More Controls**, and then tap **Label**.
- 2 Tap **Text**, and then enter the text of the new label at the top of the form.
- 3 Tap **Done**, and then drag the label to the desired location on the image.

Exporting

You can save an exam, including images and clips, to a USB memory stick for easy export.

- 1 Insert a USB memory stick into a USB port on the device.
- 2 Tap **Review**, and then tap **Patent List**.
- 3 Select a finished exam to export. Open exams cannot be exported.
- 4 Tap **Export USB**.
- 5 Select the USB memory stick from the list, and choose whether to include patient information.
- 6 Tap **Export**.

Printing

With the image displayed, tap **Print**.

Contact information

Phone (U.S. or Canada): 877-657-8118

Phone (Outside U.S. or Canada): 425-951-1330, or call your local representative

Fax: 425-951-6700

E-mail: ffss-service@fujifilm.com

Web: www.sonosite.com

Manufacturer

FUJIFILM SonoSite, Inc.
21919 30th Drive SE
Bothell, WA 98021 USA
T: 1-888-482-9449 or
1-425-951-1200
F: 1-425-951-1201

EC Authorized Representative

Emergo Europe
Molenstraat 15
2513 BH, The Hague
The Netherlands

Australia Sponsor

FUJIFILM SonoSite
Australasia Pty Ltd
114 Old Pittwater Road
BROOKVALE, NSW, 2100
Australia

X-Porte, SonoSite, and the SonoSite logo are trademarks or registered trademarks of FUJIFILM SonoSite, Inc. in various jurisdictions.

All other trademarks are the property of their respective owners.

Copyright © 2016 FUJIFILM SonoSite, Inc. All rights reserved.

P19999-03

