

---

# TEExi Transducer

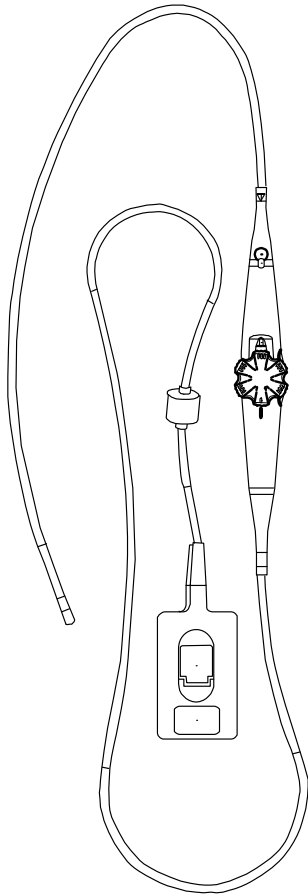

## *User Guide*

---

**FUJIFILM**  
Value from Innovation

**SonoSite**

**Manufacturer**

FUJIFILM SonoSite, Inc.  
21919 30th Drive SE  
Bothell, WA 98021 USA  
T: 1-888-482-9449 or 1-425-951-1200  
F: 1-425-951-1201

**EC Authorized Representative**

Emergo Europe  
Molenstraat 15  
2513 BH, The Hague  
The Netherlands

**Australia Sponsor**

FUJIFILM SonoSite Australasia Pty Ltd  
114 Old Pittwater Road  
BROOKVALE, NSW, 2100  
Australia

**Caution**

United States federal law restricts this device to sale by or on the order of a physician.

SonoSite M-Turbo, SonoSite Edge II, SonoSite S Series, Sonosite, and the Sonosite logo are trademarks and registered trademarks of FUJIFILM Sonosite, Inc. in various jurisdictions. Value from Innovation is a trademark of FUJIFILM Holdings America Corporation.

All other trademarks are the property of their respective owners.

Patents: US 6,371,918, CA 2,373,065, DE 60021552.0, FR 1175173 and GB 1175173.

Part Number: P21458-02

Publication date: March 2016

Copyright © 2016 FUJIFILM SonoSite, Inc. All rights reserved.



## 1. Introduction

About the user guide .....	1-1
Changes in version P21458-02 .....	1-2
Conventions .....	1-2
Warranty statement .....	1-2
Technical Support .....	1-3

## 2. Getting Started

About the TEExi transducer .....	2-1
How scan plane rotation works .....	2-1
Intended uses .....	2-2
Contraindications .....	2-2
Unpacking .....	2-3
Inspecting contents .....	2-4
Transducer and system interface .....	2-5
TEExi transducer controls .....	2-6
Tip deflection .....	2-6
Tip deflection brake .....	2-8
Scan plane rotation .....	2-9

## 3. Examination

Pre-exam inspection .....	3-1
Precautions .....	3-2
Bite guard .....	3-3
Sterile sheath .....	3-3
Emergency retraction .....	3-4

## 4. Cleaning, disinfecting, transporting, storing, and disposing of the transducer

Cleaning and disinfecting .....	4-1
Cleaning the transducer .....	4-3
Disinfecting the transducer .....	4-5
Identifying the transducer as clean .....	4-7
Transporting the transducer .....	4-7

# CONTENTS

Storing the transducer .....	4-9
Disposing of the transducer .....	4-9

## 5. Safety

Labeling symbols .....	5-1
Standards compliance .....	5-1
Annual inspection .....	5-2
Safe operational use .....	5-2
Thermal safety .....	5-3
Thermal limits .....	5-3
Reducing temperature .....	5-4
Temperature calibration test .....	5-4
Electrical safety .....	5-5
Electrical leakage testing and bite hole detection .....	5-5
Testing the endoscopic shaft .....	5-9
Transducer temperature rise .....	5-12
Output display .....	5-12
Acoustic output .....	5-13

## 6. Transducer Specifications

TEExi/8-3 MHz transducer .....	6-1
--------------------------------	-----

# CHAPTER 1

## Introduction

The TEExi transducer is a transesophageal echocardiographic transducer designed to operate with the FUJIFILM SonoSite M-Turbo, SonoSite S Series, or SonoSite Edge II ultrasound system.

Transesophageal procedures carry a variety of inherent risks to the patient. The information and instructions in this user guide are intended to help you minimize those risks. In addition, the TEExi transducer is a highly complex and delicate precision instrument. Misuse or poor handling may severely shorten the service life.

### **WARNING**

To help avoid conditions that may cause harm to the patient or damage to the transducer, it is important that personnel using or handling this transducer read and understand the instructions, warnings, cautions, and training material contained in this user guide. If you have questions about any of the information contained in this user guide, contact FUJIFILM SonoSite or your local representative.

## About the user guide

This user guide provides information on the TEExi transducer. It is designed for a reader familiar with ultrasound and proper endoscopic techniques; it does not provide training in sonography, cardiology, or clinical practices. For information about the ultrasound system, see its user guide and other appropriate literature.

To aid in safeguarding the patient and ensuring reliable transducer operation, FUJIFILM SonoSite recommends having this user guide available for reference during all stages of TEExi transducer handling.

## Conventions

The user guide follows these conventions:

- ▶ A **WARNING** describes precautions necessary to prevent injury or loss of life.
- ▶ A **Caution** describes precautions necessary to protect the products.
- ▶ A **Note** provides supplemental information.
- ▶ Numbered steps in procedures must be performed in order.
- ▶ Single-step procedures begin with ❖.
- ▶ Items in bulleted lists do not require performance in sequence.

For labeling symbols used, see the ultrasound system user guide.

## Warranty statement

The TEExi transducer is warranted for material and workmanship only, for a period of 12 months from date of shipment from FUJIFILM SonoSite.

The warranty does not cover damage caused by patient bite, misuse by the end user, disinfecting or sterilizing incorrectly or with chemicals not recommended by FUJIFILM SonoSite, or circumstances beyond what is considered normal for the product's intended application.

# Technical Support

To order sheaths, biteguards, tip covers, and other supplies, see [www.civco.com](http://www.civco.com).

For technical support, contact FUJIFILM SonoSite as follows.

<b>Phone (U.S. or Canada)</b>	877-657-8118
<b>Phone (outside U.S. or Canada)</b>	425-951-1330, or call your local representative
<b>Fax</b>	425-951-6700
<b>Email</b>	service@sonosite.com
<b>Web</b>	www.sonosite.com
<b>Europe Service Center</b>	Main: +31 20 751 2020 English support: +44 14 6234 1151 French support: +33 1 8288 0702 German support: +49 69 8088 4030 Italian support: +39 02 9475 3655 Spanish support: +34 91 123 8451
<b>Asia Service Center</b>	+65 6380-5581





## Getting Started

### About the TEExi transducer

#### WARNING

To avoid injury to a patient, the TEExi transducer is intended for use by a licensed physician who has received appropriate training in endoscopic techniques as dictated by current relevant medical practices, as well as in proper operation of the ultrasound system and transducer.

#### Caution

To avoid inadvertent damage to the transducer, read this user guide before handling and cleaning the TEExi transducer.

The TEExi transducer is an electronically steered phased array ultrasound transducer assembly, mounted in a sealed tip at the end of a conventional endoscope.

The TEExi transducer is used to generate a set of ultrasound images or slices within a cone from the same position in the esophagus. The rotation of the scan plane is driven by a motor in the control handle.

### How scan plane rotation works

To familiarize yourself with scan plane rotation, you may choose to start scanning in one of the transverse planes — for example, 0° on the system screen is the standard monoplane. If you rotate the scan plane 90°, you are now scanning in the longitudinal plane, sweeping through two opposite quadrants of the cone.

If you continue to rotate the scan plane another 90° in the same direction, scanning occurs in the mirror image of the first transverse plane. The only two planes that are equivalent are the two transverse planes at 0° and 180°, one being the mirror image of the other. As shown in **Figure 2-1** on page 2-2, a 180° rotation of the scan plane fills all four quadrants of the conic imaging volume.

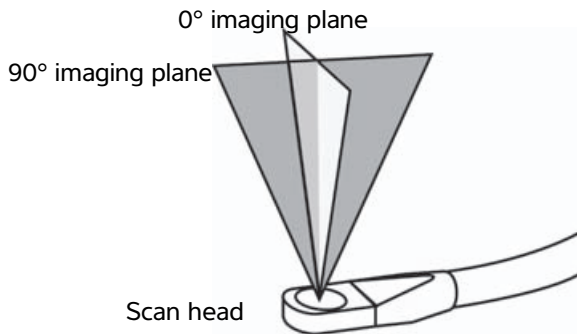

Figure 2-1 Rotating to different imaging planes

The direction of the tip of the endoscope is easily steered using the deflection control wheels on the handle of the transducer to allow exact positioning of the transducer in the esophagus.

## Intended uses

The TEExi transducer is designed for 2D, M Mode, color Doppler (Color), pulsed wave (PW) Doppler, and continuous wave (CW) Doppler imaging by applying ultrasound energy through the esophagus or stomach of the patient into the heart. The TEExi transducer is intended to be used on adults only. Backscattered ultrasound energy from the patient's heart forms images of the heart to detect abnormalities in structure or motion, to evaluate the velocity of blood flowing within the heart, and to obtain a color depiction of the velocities of blood flowing in the heart.

## Contraindications

**WARNING** | The physician must consider all possible factors before starting the examination.

Contraindications for using the TEExi transducer include, but are not limited to, the following:

- ▶ Fetal imaging
- ▶ Pediatric imaging
- ▶ Imaging when the patient exhibits the following or similar conditions:
  - ▶ Esophageal stricture, spasms, lacerations, and trouble swallowing (dysphagia)
  - ▶ Esophageal diverticula, esophageal varices (swollen veins)
  - ▶ Gastrointestinal bleeding
  - ▶ Peptic ulcers, hiatal hernia, esophageal webs and rings
  - ▶ Recent radiation treatment to the esophagus
  - ▶ Inability to swallow or accommodate the transducer

- ▶ History of gastroesophageal diseases

## Unpacking

Proper care and maintenance are essential. Follow the unpacking procedures. Contact FUJIFILM SonoSite or your local representative immediately to report any damage or discrepancies.

### WARNING

To avoid injury to patient/operator, carefully inspect all equipment after receipt and prior to each use.

### To unpack the transducer

- 1 Visually examine the shipping box, shipping case, and the TEExi transducer for any damage.
- 2 Note any breakage or other apparent damage, retain the evidence, and notify the carrier or shipping agency.
- 3 Verify that the shipping case contains the components listed on the packing list:
  - ▶ TEExi transducer
  - ▶ *TEExi Transducer User Guide*
  - ▶ *TEE Transducer Care* (contains cleaning and disinfection instructions)
  - ▶ Puncture test tool
  - ▶ Bite guards (3)
  - ▶ Non-sterile tip covers (3)

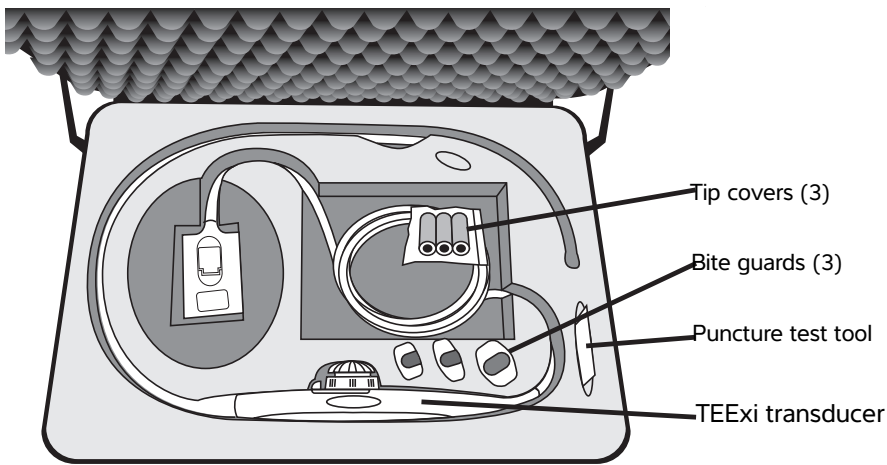

Figure 2-2 Shipping case with TEExi transducer

**WARNING**

To avoid injury to patient:

- ▶ Proper care and maintenance are essential for safe operation of the TEExi transducer.
- ▶ The medical professional performing the exam must exercise sound medical judgment in selecting this transducer for use in a procedure.

**Cautions**

- ▶ To avoid permanently damaging the transducer's internal control wires, do not deflect the transducer tip using finger pressure directly on the tip.
- ▶ To avoid inadvertent damage to the transducer, read this user guide before handling and cleaning the TEExi transducer.

## Inspecting contents

After unpacking the contents, perform the following on the TEExi transducer:

- ▶ Visual and tactile inspection. See **"To visually and tactilely inspect the transducer"** on page 2-6.
- ▶ Tip deflection inspection. See **"To inspect Tip Deflection"** on page 2-8.
- ▶ Brake inspection. See **"To inspect the tip deflection brake"** on page 2-9.
- ▶ Scan plane rotation inspection. See **"To inspect scan plane rotation"** on page 2-11.
- ▶ Leakage test. See **"Electrical safety"** on page 5-5.

Contact FUJIFILM SonoSite or your local representative immediately to report any damage or discrepancies. See **"Technical Support"** on page 1-3.

**WARNING**

To avoid injury to the patient, do not use the TEExi transducer if any irregularity, substandard function or unsafe condition is observed or suspected.

## Transducer and system interface

The TEExi transducer consists of an electronically steered phased array ultrasound transducer assembly mounted in a sealed tip at the end of a conventional endoscope. It connects to the ultrasound system with a cable and connector. See [Figure 2-3](#).

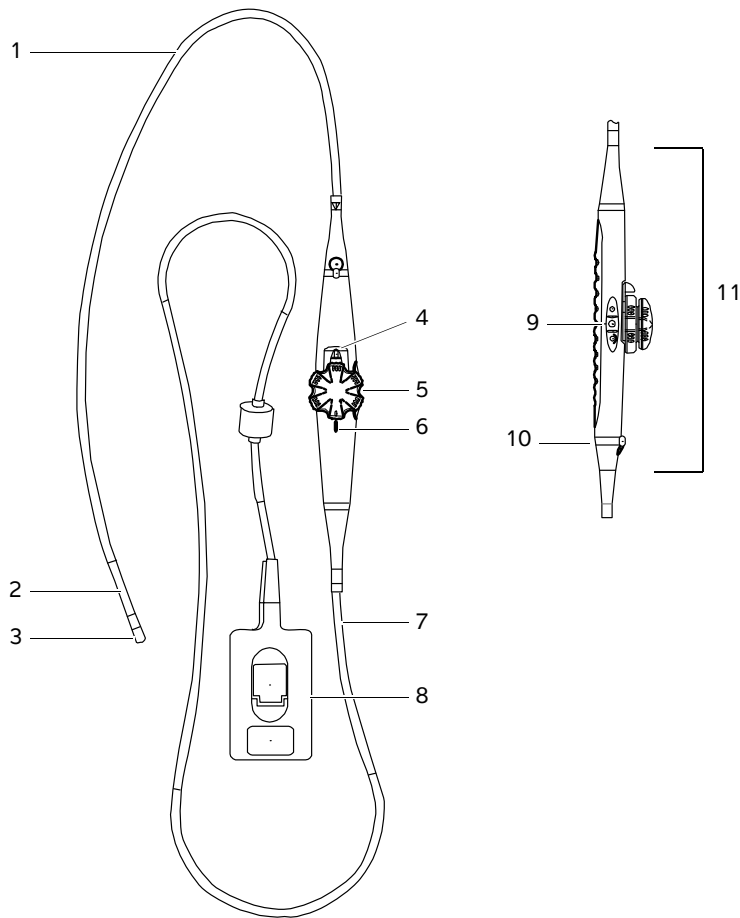

Figure 2-3 TEExi transducer:

- |   |                               |    |                            |
|---|-------------------------------|----|----------------------------|
| 1 | Flexible endoscopic shaft     | 7  | Transducer cable           |
| 2 | Articulation section          | 8  | Transducer connector       |
| 3 | Transducer tip with scan head | 9  | Scan plane control buttons |
| 4 | Deflection brake              | 10 | Attachment ring            |
| 5 | Deflection control wheels     | 11 | Handle                     |
| 6 | Neutral marker                |    |                            |

## TEExi transducer controls

The endoscope is designed for one-hand operation of the deflection and scan plane controls. **Figure 2-4** shows the user holding the endoscope handle in the left hand. Thumb and first and second fingers operate the deflection and scan plane controls.

Check the mechanical operation and physical integrity of the transducer after taking it out of the box and before each exam.

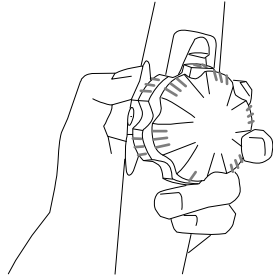

Figure 2-4 Transducer in left hand

### WARNING

To avoid injury to the patient:

- ▶ Do not use the TEExi transducer if any irregularity, substandard function or unsafe condition is observed or suspected.
- ▶ Do not use the TEExi transducer if any metallic protrusions, holes, rough spots, cracks, or dents are found.

### To visually and tactilely inspect the transducer

You should inspect the TEExi transducer visually and tactilely after taking it out of the box and before disinfecting.

- 1 Visually examine and feel the entire surface of the flexible shaft and deflection section with the transducer in both straight and deflected position.
- 2 Examine the transducer tip for any holes or dents.

### Tip deflection

The TEExi transducer handle has two wheels for controlling the transducer tip deflection.

The wheels control anterior/posterior and left/right tip deflection. **Figure 2-5** on page 2-7 shows the deflection wheels in the neutral (undeflected) position. (There is no brake for left/right deflection.)

The lower wheel has brake and freely-moving modes. In the brake mode, the movement of the deflection wheel is restrained. This is for holding the tip in a certain position.

Special care should be taken when inserting and removing the transducer.

**Caution** To avoid damaging the transducer, do not deflect the distal tip of the transducer by direct application of force. Use the deflection wheels for this task.

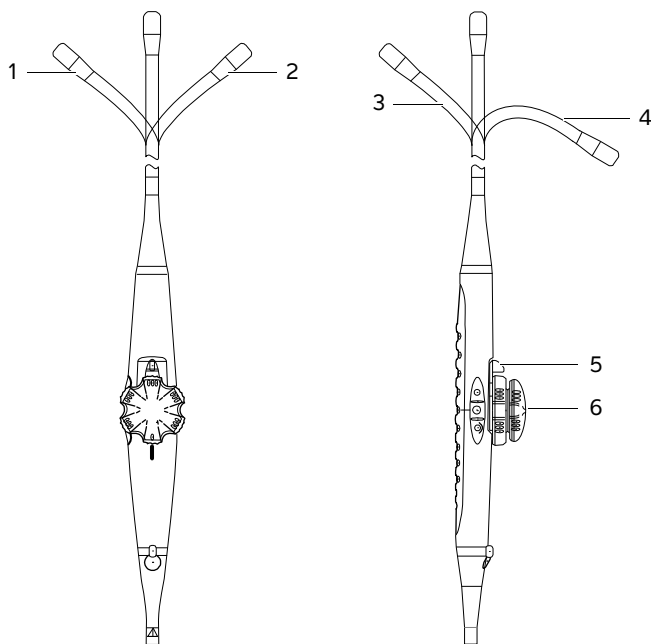

**Figure 2-5** Deflection controls. For orientation purposes, hold the transducer pointing away with control wheels up and the flexible shaft in a straight position.

- 1 Turn upper wheel counterclockwise to move the tip to the left.
- 2 Turn upper wheel clockwise to move the tip to the right.
- 3 Turn lower wheel counterclockwise to move the tip posterior.
- 4 Turn lower wheel clockwise to move the tip anterior.
- 5 Lower deflection control wheel
- 6 Upper deflection control wheel

**WARNING**

To avoid injury to the patient, if you observe a sharp “U-turn” of the transducer tip during the tip deflection inspection, do not use the transducer.

**To inspect Tip Deflection**

Inspect the tip deflection on the TEExi transducer after taking it out of the box and before each exam. For orientation purposes, hold the transducer pointing away with control wheels up and the flexible shaft in a straight position.

- 1 Deflect the tip in all four directions.
- 2 Confirm that the deflection controls operate smoothly.
- 3 Check that when the deflection controls are in the neutral position that the transducer tip is also in a neutral position (undeflected).

**Tip deflection brake**

To retain the tip in a deflected position, friction can be applied to the anterior/posterior deflection control.

The brake for the anterior/posterior deflection is a handle under the deflection wheel (see [Figure 2-6](#)). There is no brake for the right/left deflection.

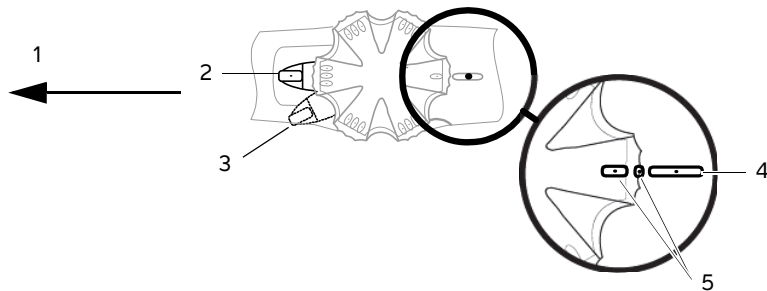

**Figure 2-6** Tip deflection brake operation

- |   |                                              |   |                         |
|---|----------------------------------------------|---|-------------------------|
| 1 | Transducer tip                               | 4 | Neutral position marker |
| 2 | Tip control in unlocked position (brake off) | 5 | Wheel position markers  |
| 3 | Tip control in locked position (brake on)    |   |                         |



## To inspect the tip deflection brake

Inspect the tip deflection brake on the transducer after taking it out of the box and before each exam.

- 1 Confirm that the brake is in the unlocked position.
- 2 Deflect the tip to the anterior direction.
- 3 Move the brake to the locked position.
- 4 Confirm that the tip is locked in the deflected position.
- 5 Unlock the brake and confirm that the tip straightens easily.
- 6 Repeat steps 1-5 for the posterior direction.

## Scan plane rotation

The scan plane rotation is driven by a motor in the transducer handle and is controlled by buttons on the handle (see [Figure 2-7](#)).

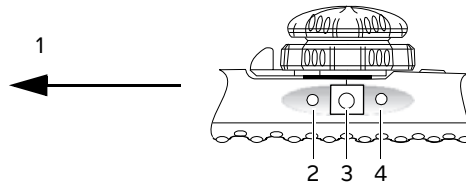

**Figure 2-7** Scan plane rotation controls

- 1 Transducer tip
- 2 Counterclockwise button (increases angle)
- 3 Biplane button (rotates angle to orthogonal biplane)
- 4 Clockwise button (decreases angle)

A scan plane indicator on the system screen shows the orientation. The scan plane angle is indicated by a marker and a value. See [Figure 2-8](#). The screen shows the angle relative to the standard monoplane, displayed as 0°. The scan plane angle ranges from 0° to 180°.

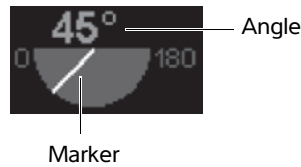

Figure 2-8 Scan plane indicator

**Caution** To avoid damaging the transducer connector, protect the connector from dirt and moisture.

### To initialize the scan plane to 0 degree plane

- 1 Connect the transducer, and turn on the ultrasound system. (For instructions, see the ultrasound system user guide.)
- 2 Press the scan plane rotation buttons.

### To rotate the scan plane

- ❖ Press the outer buttons on the transducer handle:
  - ▶ The button closest to the transducer tip rotates the scan plane counterclockwise (scan plane angle increases).
  - ▶ The button farthest from the transducer tip rotates the scan plane clockwise (scan plane angle decreases).

The scan plane rotates 180° from a standard transverse plane (short axis) to the longitudinal plane (long axis), ending at the mirror image of the first transverse plane (short axis). The angular position appears on the system screen. The 0° short axis reference position is defined as follows: When you view the transducer through the acoustic window of the transducer tip, the transducer is in the extreme clockwise position.

### To change the Biplane

- ❖ Press the biplane button (the center button) on the transducer handle. See [Figure 2-7](#) on page 2-9. The scan plane rotates at full speed from the current position to the orthogonal position. (For example, if the present position is 22°, the scan plane rotates to 112°. If the present position is 162°, the scan plane rotates to 72°.)

Pressing the button again rotates the scan plane back to the previous position.

## To inspect scan plane rotation

Inspect the scan plane rotation on the transducer after taking it out of the box and before each exam.

- 1 Connect the TEExi transducer to the ultrasound system.
- 2 Without inserting the transducer, place a small amount of sterile gel on the transducer, and then turn up the gain to obtain an image.
- 3 Press the scan plane control buttons on the handle to rotate the scan plane counterclockwise ( $0^\circ$  to  $180^\circ$ ) and clockwise ( $180^\circ$  to  $0^\circ$ ). See [Figure 2-7](#) on page 2-9.
- 4 Confirm that the image on-screen changes in relation to the numbers on the scan plane indicator. See [Figure 2-8](#) on page 2-10.

While you press the scan plane rotation buttons, the transducer motor should be running as the image is changing.

### Note

Do not rely only on the scan plane indicator on-screen to verify that the scan plane is rotating.



## Examination

While echocardiographs from the transesophageal or transgastric position provide important clinical data not available from any other view, the examining physician must consider a number of conditions when selecting a patient for safe use of the transducer. The list of contraindications and considerations do not constitute a complete list of all possible factors the examining physician must consider before starting the examination. They are presented only as examples. See **“Contraindications”** on page 2-2.

### WARNINGS

- ▶ To avoid trauma to the patient’s stomach or esophagus, do not use excessive force during insertion, positioning, or withdrawal.
- ▶ To prevent damage to the patient’s esophagus when inserting or withdrawing the transducer, the control wheel must be in the freely moving, neutral, and unlocked state. See **Figure 2-6** on page 2-8.

## Pre-exam inspection

It is important to establish and use a check-out procedure to ensure that the transducer is safe to use and functions properly prior to each use. If you observe or suspect any irregularity, substandard functioning, or unsafe condition, do not use the TEExi transducer. Call FUJIFILM SonoSite or your local representative immediately.

Perform the following before each exam:

- ▶ Visual tactile inspection. See **“To visually and tactilely inspect the transducer”** on page 2-6.
- ▶ Tip deflection inspection. See **“To inspect Tip Deflection”** on page 2-8.
- ▶ Brake inspection. See **“To inspect the tip deflection brake”** on page 2-9.
- ▶ Scan plane rotation inspection. See **“To inspect scan plane rotation”** on page 2-11.
- ▶ Leakage test or bite-hole inspection test. See **“Electrical leakage testing”** on page 5-5 or **“Bite hole detection”** on page 5-5.

- ▶ Clean and disinfect transducer. See “[Cleaning and disinfecting](#)” on page 4-1.

Contact FUJIFILM SonoSite or your local representative to report any damage or discrepancies. See “[Technical Support](#)” on page 1-3.

### WARNINGS

To avoid injury to the patient:

- ▶ FUJIFILM SonoSite recommends performing the above procedures prior to each exam.
- ▶ Do not use the transducer if any metallic protrusions, holes, rough spots, cracks, or dents are found.
- ▶ If during the deflection test a sharp “U-turn” of the transducer tip is observed (the transducer tip angle exceeds the maximum deflection angles), do not use the transducer. Call FUJIFILM SonoSite or your local representative.
- ▶ Some gels and sterilants can cause an allergic reaction in some individuals.

## Precautions

Techniques for introducing the TEExi transducer into the patient are beyond the scope of the user guide. There are numerous medical texts and articles that thoroughly address this topic. Observe the following precautionary measures when conducting an exam.

- ▶ Maintaining an unobstructed airway is a prime consideration for all patients.
- ▶ Prolonged pressure on the esophagus by the tip of the transducer may lead to a pressure necrosis condition. Thus, in operating room monitoring applications, the tip should be removed from the esophagus wall when not scanning, by releasing it in the neutral position. If continuous monitoring is required, the transducer tip should be repositioned often.
- ▶ Long term exposure to ultrasound should be minimized. Although there have never been any bioeffects demonstrated at the acoustic output levels of the TEExi transducer, it is prudent to minimize patient exposure to ultrasound according to the principle of ALARA (As Low As Reasonably Achievable). Please see the ultrasound system user guide.
- ▶ In consideration of the above two points, you should freeze the image, which turns off the power to the transducer, and allow the endoscope deflection controls to be disengaged whenever active scanning is not desired.
- ▶ Proper patient preparation is essential for successful examinations. This includes restrictions on food and liquid intake as well as a thorough explanation of the examination procedure and other instructions as the particular situation warrants.
- ▶ The use of a bite guard during all TEExi examinations is mandatory to protect the transducer from possible damage.
- ▶ The use of protective gloves during the examination is encouraged. Please see the U.S. Food and Drug Administration’s Medical Alert on Latex Products (FDA 1991).

- ▶ In addition to the high level disinfection, a protective sheath may provide even greater protection against contamination of the transducer. Contact CIVCO for protective sheaths and applicators for protective sheaths.

## Bite guard

### Caution

To avoid damaging the transducer, use a bite guard during all TEExi examinations. Biting the endoscope may cause severe, permanent damage to the transducer, making it unsafe for future patient use. Damage to the transducer from failure to use a bite guard voids the transducer warranty.

Each TEExi transducer from FUJIFILM SonoSite is delivered with three bite guards. Use of a bite guard is mandatory. If you need help ordering more bite guards, contact CIVCO Medical Solutions.

Re-use, cleaning, and sterilization of the bite guards should be done according to instructions provided by the manufacturer of the bite guard.



Figure 3-9 Bite guard: Side view (left) and front view (right)

## Sterile sheath

Use a sterile sheath whenever examining a patient that poses an isolation risk.

There are various sterile sheaths available to eliminate direct contact between the patient and the endoscope. Follow the user instructions for a particular sheath when applying and removing the sheath from the TEExi transducer. Contact CIVCO to order sterile sheaths and applicators for sterile sheaths.

### Caution

To avoid damaging the TEExi transducer, ensure that its tip is straight during application and removal of the sheath. During removal of the sheath, be careful not to use excessive force on the transducer tip; otherwise permanent damage to the TEExi transducer may occur.

To provide suitable acoustic coupling within the sheath, FUJIFILM SonoSite recommends using a sterile gel.

## To install a transducer sheath

### Note

FUJIFILM SonoSite recommends the use of market-cleared, transducer sheaths for intracavitary applications. To lessen the risk of contamination, install the sheath only when you are ready to perform the procedure.

- 1 Place gel inside the sheath.
- 2 Insert the transducer into the sheath.
- 3 Pull the sheath over the transducer and cable until the sheath is fully extended.
- 4 Secure the sheath by taping it to the transducer housing.
- 5 Check for and eliminate bubbles between the footprint of the transducer and the sheath.

Any bubbles between the footprint of the transducer and the sheath can affect the ultrasound image.

- 6 Inspect the sheath to ensure that there are no holes or tears.

## Emergency retraction

If the transducer tip should get jammed in a deflected position inside the patient and if all attempts to release the deflected tip should fail, follow the procedure To retract the transducer to assure a safe retraction of the transducer.

### To retract the transducer

- 1 Disconnect the transducer from the ultrasound system.
- 2 At an accessible location between the transducer handle and the patient, cut the entire endoscope shaft, including all internal wiring, using heavy duty cutting pliers or another suitable tool.

The deflection mechanism is now released and the transducer may be safely retracted.



# CHAPTER 4

## Cleaning, disinfecting, transporting, storing, and disposing of the transducer

### Cleaning and disinfecting

The TEExi transducer is categorized as semi-critical in the Spaulding classification system and must be cleaned and disinfected after each exam. It is important that the cleaning and disinfection process not be rushed or shortened.

In addition to protecting patients and employees from disease transmission, the disinfectant you choose must be safe for the transducer. FUJIFILM SonoSite routinely reviews new medical disinfectants for compatibility with the transducer control housing, cable, endoscopic shaft, and scan head. For the latest list of compatible disinfectants, see [Table 4-2, “Approved disinfectants and soak times”](#) on page 4-5.

Some components of the TEExi transducer have different cleaning requirements and restrictions than others. The cleaning and disinfection procedures frequently refer to specific components of the transducer. See [Figure 4-1](#) on page 4-2 for a diagram of the transducer components and their names.

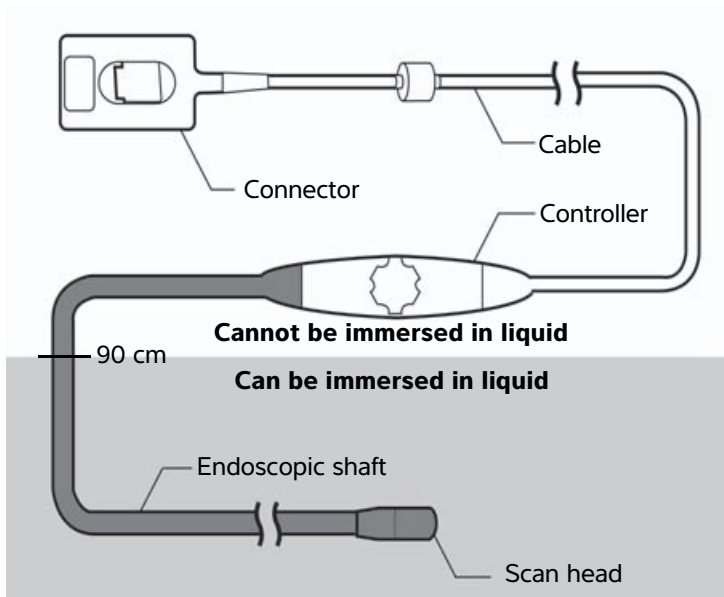

Figure 4-1 Transducer component names

Carefully follow the chemical manufacturer’s instructions and recommendations for preparing, using, and disposing of cleaning and disinfection solutions. Check the expiration dates, and do not use solutions that have surpassed their expiration dates. Follow the manufacturer’s recommendations for verifying the concentration and efficacy of all cleaning and disinfection solutions (for example, a chemical strip test).

## Cleaning the transducer

### WARNING

Be sure to use the appropriate Personal Protective Equipment (PPE) whenever necessary.

### Cautions

- ▶ Always disconnect the transducer from the system before cleaning. When disconnecting the transducer from the system, follow the steps in the ultrasound system user guide.
- ▶ Do not bend the endoscopic shaft smaller than a 20 cm (8 inch) curve. Exceeding this minimum bend diameter can damage the endoscope or its watertight coating.
- ▶ Do not use unapproved cleaning agents, such as alcohol or bleach (for example, Sani-Cloth™ wipes) as these can damage the transducer. For more information about approved cleaning agents, see [Table 4-1](#).
- ▶ Do not skip any steps or abbreviate the cleaning and disinfection process in any way.

Before using any cleaning agent that is not listed in the table below, contact FUJIFILM SonoSite to verify that it will not damage the transducer.

### To clean the transducer

**Table 4-1: Enzymatic cleaners**

Cleaner	Concentration/Temperature	Duration
Prolystica	1 - 5% at 33-43° C, 91-109° F	2 - 5 minutes, then rinse immediately
Hexanios G+R	0.5%, at less than 45° C, 113° F	15 minutes
Aniosyme DD1	0.5%, at 38° C, 100° F	15 minutes
Salvanios pH7	0.5%, at 38° C, 100° F	15 minutes
Cidezyme/Enzol	1 - 10%, at 38° C, 100° F	1 - 3 minutes

- 1 At the point of use, immediately after extracting the TEExi from the patient, wipe the transducer, including the cable, controller, endoscopic shaft, and scan head with a cloth or wipe moistened with water. Be sure to remove all visible biological material. Do not wipe the connector.
- 2 At the cleaning station, check the expiration date of the cleaner. Check the temperature and concentration of the cleaning solution.

- 3 Secure the control handle so it cannot fall into the cleaning solution. Soak the endoscopic shaft in a plastic container filled with enzymatic cleaning solution according to the concentration and soak time indicated in **Table 4-1, “Enzymatic cleaners”** on page 4-3. Scrub the endoscopic shaft for at least three minutes using a soft brush or single-use endoscopic sponge moistened with enzymatic cleaner. Follow the chemical manufacturer’s precautions and instructions, and observe dilution rates.

**Cautions**

- ▶ Do not soak the transducer longer than recommended by the chemical manufacturer.
- ▶ Do not immerse the system cable, connector, or controller in any fluid.

- 4 While the endoscope is soaking, clean the control handle and cord by wiping with a clean, non-linting cloth or single-use endoscopic sponge moistened with one of the cleaners listed in **Table 4-1, “Enzymatic cleaners”** on page 4-3. To remove any residual cleaner, wipe both components again with a clean, non-linting cloth or single-use endoscopic sponge moistened with water. Do not wipe the connector.
- 5 Rinse the endoscopic shaft by soaking it in a large volume of clean, lukewarm water (for example, eight liters) for at least three minutes to remove residual cleaning solution. Residual cleaners left on the transducer can cause damage.
- 6 Visually inspect the scan head and endoscopic shaft for remaining biological material. If any is found, repeat the cleaning process.
- 7 Test the transducer for bite holes. For information about leakage and bite hole detection, see **“Electrical leakage testing and bite hole detection”** on page 5-5.

**Caution**

If the watertight coating on the scan head or endoscopic shaft has been damaged or punctured, contact FUJIFILM SonoSite for instructions on cleaning and returning the transducer for repair.

- 8 Dry the transducer with a clean, non-linting towel.
- 9 Examine the transducer and cable for damage, such as cracks or splitting where fluid can enter. If damage is evident, discontinue use of the transducer, and contact FUJIFILM SonoSite or your local representative.
- 10 Proceed immediately to the disinfection process. See **“Disinfecting the transducer”** on page 4-5.

## Disinfecting the transducer

**Caution** | Do not steam, autoclave, or expose the transducer to Ethylene Oxide.

If using an automated disinfection process, follow manufacturer procedures. For manual disinfection, use the following procedure:

### To disinfect the transducer

**Table 4-2: Approved disinfectants and soak times**

Disinfectant	Temperature	Duration
Anioxyde 1000	23° C, 73° F	15 minutes
Cidex	25° C, 77° F	45 minutes
Cidex OPA	20° C, 68° F	12 minutes
Korsolex extra	Less than 45° C, 113° F	15 minutes
Metricide	25° C, 77° F	45 minutes
Nu-Cidex	20° C, 68° F	15 minutes
PeraSafe	less than 45° C, 113° F	15 minutes
Sekusept AKtiv	less than 45° C, 113° F	15 minutes
TD-100 & TD-5	Auto	Auto
Tristel Generator Solution	Auto	Auto
Wavicide-01	24° C, 75° F	45 minutes

- 1 Verify that the transducer has been cleaned using the procedure described in “[Cleaning the transducer](#)” on page 4-3.
- 2 If you are using an automated disinfection process, skip the rest of this procedure and refer to the manufacturer’s instructions. To manually disinfect the transducer, proceed to step 3.
- 3 At the disinfection station, check the expiration of the disinfectant. Check the temperature and concentration of the solution.
- 4 Disinfect the cable and controller by wiping them with a sterile, non-linting cloth or single-use endoscopic sponge moistened with disinfectant solution.
- 5 Rinse the cable and connector by wiping them with a sterile, non-linting cloth or single-use endoscopic sponge moistened with sterile water.

- Secure the control handle so it cannot fall into the cleaning solution. Disinfect the transducer by soaking the shaft in the disinfection fluid. Do not exceed the soak time indicated in [Table 4-2, “Approved disinfectants and soak times”](#) on page 4-5.

**WARNING**

Do not soak the transducer longer than recommended by the chemical manufacturer. Prolonged soaking in chemical disinfectants can cause damage to the transducer and chemical burns to the patient.

**Cautions**

- Do not use unapproved disinfecting agents, such as alcohol or bleach (for example, Sani-cloth wipes) as these can damage the transducer. For more information about approved disinfecting agents, see [Table 4-2, “Approved disinfectants and soak times”](#) on page 4-5.
- Do not immerse the system cable, connector, or controller in any fluid.

- Rinse the transducer by soaking it for at least one minute, in a large volume of sterile, deionized water (for example, eight liters). Discard the rinse water.

**WARNING**

Chemical disinfectants can cause harm to the patient if not completely removed from the transducer. For more information, see the disinfectant manufacturer’s instructions.

- Important:** To ensure that no residual disinfectant remains on the scan head or endoscopic shaft, repeat **step 7** at least two more times for a minimum total of **three rinse cycles**. Dispose of the water after each rinse. Some disinfectant manufacturers may recommend additional rinsing. See the manufacturer’s guidelines for more information.

- Dry the transducer with a sterile, non-linting towel or medical-grade air.

- Examine the transducer and cable for damage, such as cracks or splitting where fluid can enter. If damage is evident, discontinue use of the transducer, and contact FUJIFILM SonoSite or your local representative.

- If not already in place, apply a clean tip cover over the transducer scan head. The tip cover encloses and protects the scan head from mechanical strain and impact during transportation and storage. Keep the tip cover on until preparing the transducer for use.

**Cautions**

- The tip cover is a single-use device. Do not reuse tip covers. Doing so can result in contamination of, or damage to the scan head.
- When handling a clean transducer, always take appropriate precautions to prevent cross-contamination.

- 12 To transport the transducer, refer to the procedures detailed in “[Transporting the transducer](#)” on page 4-7
- 13 To store the transducer, refer to the procedure detailed in “[Storing the transducer](#)” on page 4-9.
- 14 Dispose of the disinfectant according to the manufacturer’s guidelines.

**WARNING** | Wear the appropriate personal protective equipment (PPE) when handling disinfectants.

## Identifying the transducer as clean

To identify the transducer as clean, containers used to transport clean transducers should carry a verification sticker or certificate that include the date cleaned and the name (or other identification) of the person who performed the cleaning.

## Transporting the transducer

When transporting the TEExi transducer, you must take precautions to protect the transducer from damage and avoid cross-contamination. Be sure to use a container approved by your organization.

**Caution** | Do not bend the endoscopic shaft smaller than a 20 cm (8 inch) curve. Exceeding this minimum bend diameter can damage the endoscope or its watertight coating.

### To transport a soiled transducer for cleaning

A soiled transducer is one that has been contaminated and must be cleaned before using it in an exam.

- 1 Place the transducer in a clean, approved container.

**WARNING** | To prevent cross-contamination or unprotected exposure of personnel to biological material, containers used to transport contaminated transducers should carry an ISO biohazard label similar to the following:



**Caution** | Ensure the transducer is dry before placing it in a closed container. Condensation from a damp transducer can damage the connector and endoscope.

- 2 Transport the transducer in the container to the point of processing. Do not open the container until the transducer is ready to be cleaned.

**Caution** | Do not leave the TEExi transducer in a sealed container for long periods of time.

### To transport a clean transducer

A clean transducer is one that has completed the cleaning and disinfection process, has been stored properly, and is ready to be used in an examination.

- 1 Place the transducer in a clean, approved container. To identify the transducer as clean, containers used to transport clean transducers should carry a cleanliness verification sticker or certificate. For more information, see “**Identifying the transducer as clean**” on page 4-7.
- 2 Transport the transducer in the container to the point of use. Do not open the container until the transducer is ready to be used.

### To ship a transducer

**WARNING** | Whenever possible, avoid shipping a contaminated transducer. Before shipping, ensure the transducer has been cleaned and disinfected using the steps detailed in “**Cleaning and disinfecting**” on page 4-1 or according to special instructions received from FUJIFILM SonoSite. If you are returning the transducer to FUJIFILM SonoSite, document the disinfection on a “Declaration of Cleanliness,” and attach it to the packing list.

- 1 If not already in place, insert a tip cover over the transducer scan head.

**Caution** | The tip cover is a single-use device. Do not reuse tip covers. Doing so can result in contamination of, or damage to, the scan head.

- 2 Place the transducer in the shipping case and seal it.

**Caution** | When shipping the transducer in the shipping case, do not allow any part of the transducer to protrude beyond the case.

- 3 Ship the transducer using the following precautions:

- ▶ Clearly label the case as fragile.



- ▶ Do not stack items on top of the case.
- ▶ Do not exceed the shipping temperature range: -35° C (-31° F) to +65° C (149° F).
- ▶ Do not open the case until it reaches its final destination.

After arrival, the transducer must be cleaned and disinfected using the procedures detailed in “[Cleaning and disinfecting](#)” on page 4-1 before it can be used.

## Storing the transducer

### To store the transducer

- 1 Clean and disinfect the TEEp transducer. See “[Cleaning and disinfecting](#)” on page 4-1.
- 2 Store the transducer so that it hangs freely and vertically, and observe the following precautions:

- ▶ Store the transducer away from any contaminated transducers.
- ▶ Store the transducer in an environment that is safe and has good airflow. Do not store the transducer in closed containers or where condensation may occur.
- ▶ Use a tip cover when storing the transducer to prevent damage to the scan head. The tip cover encloses and protects the scan head from mechanical strain and impact during storage. Keep the tip cover on until preparing the transducer for use.

#### Caution

The tip cover is a single-use device. Do not reuse tip covers. Doing so can result in contamination of, or damage to, the transducer.

- ▶ Avoid direct sunlight and exposure to x-rays. Recommended storage temperature range is between 0° C (32° F) and +45° C (113° F).
- ▶ If using a wall-mounted rack for storage, ensure that:
  - ▶ It is securely mounted.
  - ▶ The storage slots do not mar the transducer or the endoscopic shaft.
  - ▶ The rack is sized and positioned to prevent the transducer from inadvertently falling.
- ▶ Make sure the connector is supported and secure.

## Disposing of the transducer

#### WARNING

Do not destroy the transducer by incinerating or burning it. Return the transducer to FUJIFILM SonoSite or your local representative for disposal.



## Safety

Patient safety is ensured only when a well-designed product is used in a safe and responsible manner.

It is important that the user establishes and uses a check-out procedure to ensure that the transducer is safe to use and functions properly prior to each use. If any irregularity, substandard functioning, or unsafe condition is observed or suspected, do not use the TEExi transducer. Contact FUJIFILM SonoSite or your local representative immediately.

### WARNING

The TEExi transducer has no protection in the event of a neutral electrode fault of a high frequency surgical device. When using the TEExi transducer with high frequency surgical equipment, monitor the scan head temperature and remove the transducer from the area if you observe an increase in temperature.

## Standards compliance

The TEExi transducer conforms to the Medical Device Directive 93/42/EEC. It is a class IIA medical device. Symbols and terms used on the transducer are explained in the ultrasound system user guide.

For a list of applicable standards and requirements, see the ultrasound system user guide.

## Annual inspection

In addition to the regular inspections described elsewhere in this document, perform the following tests at least annually on the TEExi transducer:

- ▶ Temperature calibration test. See **“Temperature calibration test”** on page 5-4.
- ▶ Leakage current test. See **“Electrical leakage testing”** on page 5-5.

## Safe operational use

### WARNINGS

To avoid injury to the patient:

- ▶ Consult the medical literature regarding techniques, complications, and hazards prior to transesophageal procedures. Study this user guide thoroughly prior to performing a transesophageal procedure.
- ▶ The TEExi transducer is intended for use by a medical professional who has received appropriate training in endoscopic techniques as dictated by current relevant medical practices, as well as in proper operation of the ultrasound system and transducer.
- ▶ Check the transducer prior to each use to assure that it is safe to use and functions properly. If any irregularity, substandard functioning, or unsafe condition is observed or suspected, do not use the TEExi transducer. Call FUJIFILM SonoSite or your local representative. See **“Pre-exam inspection”** on page 3-1.
- ▶ If the transducer tip should get jammed in a deflected position inside the patient, and all attempts to release the deflected tip should fail, follow procedure for **“Emergency retraction”** on page 3-4 to assure a safe retraction of the transducer. The deflection mechanism is designed to provide safe operation during normal use.
- ▶ Perform a bite hole detection test after cleaning the transducer, but before disinfecting it. If a bite hole is detected, do not use the transducer. See **“Bite hole detection”** on page 5-5.
- ▶ Do not use conventional coupling gel intended for external use.
- ▶ Avoid forceful intubation pressure which can cause lacerations or perforation of the gastrointestinal tract.
- ▶ Remove the transducer from the patient when using a defibrillator.
- ▶ FUJIFILM SonoSite recommends cleaning and disinfecting transducers after each use. See **“Cleaning and disinfecting”** on page 4-1.

### WARNINGS

- ▶ To avoid injury to the patient and damage to the transducer, use a bite guard during all transesophageal exams.
- ▶ To maintain proper level of sterility, the use of a protective sheath in addition to the high level disinfection, may provide the proper level of protection against contamination of the transducer.
- ▶ Some transducer sheaths contain natural rubber latex and talc, which can cause allergic reactions in some individuals. See 21 CFR 801.437, User labeling for devices that contain natural rubber.

### Cautions

- ▶ To avoid damaging the equipment, clean and disinfect the transducer using the recommended procedures only.
- ▶ To avoid damaging the transducer, the TEExi transducer shall be handled only by trained personnel. The TEExi transducer is a precision instrument and can be inadvertently damaged.

## Thermal safety

Experts generally agree that to avoid damage to body tissues during long-term exposures, the temperature of the transducer tip where contacting tissue should be less than 43° C.

A thermal-safety system in the ultrasound system displays the transducer's operating temperature on-screen and prevents it from exceeding given limits.

If the temperature sensor is not working properly when you connect the transducer to the system, the image freezes and a warning appears.

### Thermal limits

The system has two levels of upper thermal limit: 41.0° C and 42.5° C. If the transducer-tip temperature reaches 41.0° C, the temperature is highlighted on-screen, the image freezes, and a warning appears. This warning appears only once per exam. To continue, press OK. If the temperature reaches 42.5° C, the image freezes and cannot be unfrozen until the temperature falls below 42.0° C. To resume imaging, press the FREEZE or UNFREEZE key.

The system has a lower thermal limit of 17.5° C. If the transducer-tip temperature reaches 17.5° C, the temperature is highlighted on-screen, and the image freezes and cannot be unfrozen until the temperature rises above 18.0° C. To resume imaging, press the FREEZE or UNFREEZE key.

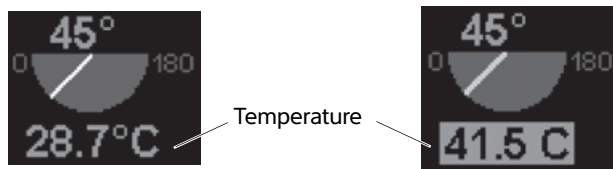

Figure 5-1 Transducer-tip temperature on-screen: Within limit (left) and outside limit (right)

## Reducing temperature

The following are general guidelines for reducing temperature in 2D or Doppler imaging modes:

- ▶ Using 2D imaging (2D imaging typically results in the lowest transducer surface temperature.)
- ▶ In 2D imaging, selecting the Res or Gen optimization setting and increasing the image depth
- ▶ In PW Doppler imaging, decreasing the PRF and/or positioning the Doppler sample gate to a shallower depth
- ▶ In CW Doppler imaging, no imaging changes reduce the transducer surface temperature.
- ▶ In any imaging mode, freezing the image temporarily reduces the transducer surface temperature.
- ▶ In color imaging, no imaging changes reduce the transducer surface temperature.

## Temperature calibration test

At least once a year, verify the temperature measurement function to the specifications. See “[Thermal safety](#)” on page 5-3.

To prepare for the temperature calibration test, assemble the following items:

- ▶ Temperature stabilized water bath
- ▶ Temperature gauge with accuracy of  $\pm 0.1^\circ \text{C}$

### To test the temperature calibration

- 1 Adjust the water bath temperature to  $41.8^\circ \pm 0.1^\circ \text{C}$  and monitor the temperature with the gauge.

If an accurate and stable water bath is not available, account for the added inaccuracy when reading the temperature from the ultrasound system. Deviation of more than  $\pm 0.5^\circ \text{C}$  is not acceptable. Maintaining this accuracy without temperature regulation may be difficult.

- 2 Connect the TEExi transducer to the ultrasound system or select it if you are using the Triple Transducer Connect.
- 3 Press **FREEZE**.
- 4 Put the transducer tip in the water bath.

At least 10 cm of the distal end must be submerged.

- 5 Observe the temperature indicated on the system screen.
- 6 Wait until the temperature display is stabilized at  $41.8^\circ \pm 0.5^\circ \text{C}$  plus/minus any water bath temperature deviation.

7 Observe that the Warning pop-up window appears.

If the temperature shutdown works as described in “**Thermal safety**” on page 5-3, the transducer passes the test. If not, contact FUJIFILM SonoSite or your local FUJIFILM SonoSite representative.

## Electrical safety

You should perform the electrical leakage current test on the TEExi transducer after taking it out of the box. You should also perform it either before each exam or—if you perform the bite-hole inspection test before each exam—yearly (at a minimum).

### Electrical leakage testing and bite hole detection

The endoscope shaft does not have any electrically conducting surfaces and is covered with a layer of material that does not permit fluids nor electricity to pass through it. The transducer’s electrical safety is maintained by keeping this material intact. Punctures in this material, such as those resulting from bites or improper handling, can result in fluids entering the endoscopic shaft and the patient being exposed to an electrical current. FUJIFILM SonoSite tests each TEExi transducer for electrical isolation and leakage current before it is shipped to a customer.

It is important that you establish and use a standardized procedure to ensure that the transducer is safe to use and functions properly prior to each use. If any irregularity, substandard functioning, or unsafe condition is observed or suspected, do not use the TEExi transducer. Call FUJIFILM SonoSite or your local representative.

#### **WARNING**

To avoid injury to the patient, do not use the transducer if the insulating material has been punctured or otherwise compromised.

#### **Note**

Electrical leakage testing and bite hole detection are separate procedures that may be performed at different times.

### Electrical leakage testing

You should establish a program for measuring the electrical leakage current on a regular basis. As a minimum, electrical current leakage tests must be performed once per year, or as required by local regulation.

#### **WARNING**

Only qualified personnel should measure electrical leakage current. Take all necessary precautions to avoid contact with non-insulated parts that have applied voltage.

### Bite hole detection

A basic understanding of the TEExi transducer components is important to successfully performing a bite hole detection test. In this guide, you will find references to the following components:

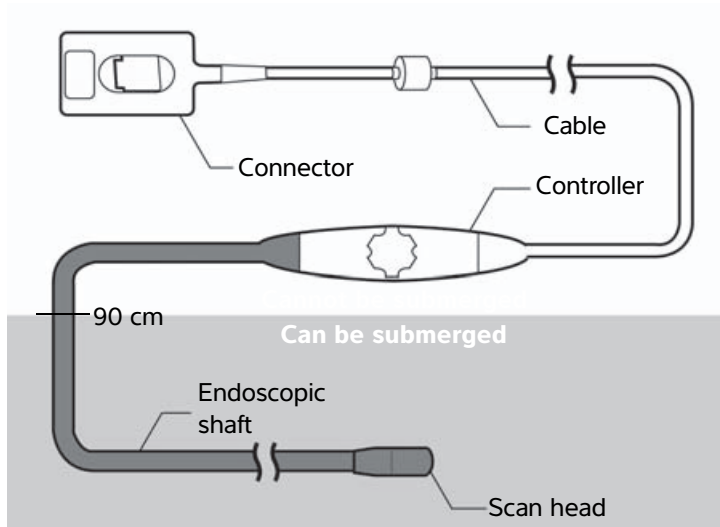

Figure 5-2 TEExi components

You should maintain a record of electrical current leakage and bite hole test results for each TEExi transducer.

### Preparing for bite-hole/electrical leakage testing

Test both the transducer array and the endoscopic shaft for bite holes. You can use the same equipment for both tests, however the tester connection points are different for each test.

Assemble the following items for each test:

- ▶ Water bath with a 5% saline solution (50g NaCl/1 liter water)
- ▶ A conductor plate made of copper or aluminum with an area of at least 25 cm<sup>2</sup> (one is included with bite hole indicator kit).
- ▶ Bite hole indicator with leads.
- ▶ Puncture test tool.

### Testing the transducer array



## To test the transducer array for bite holes or current leakage

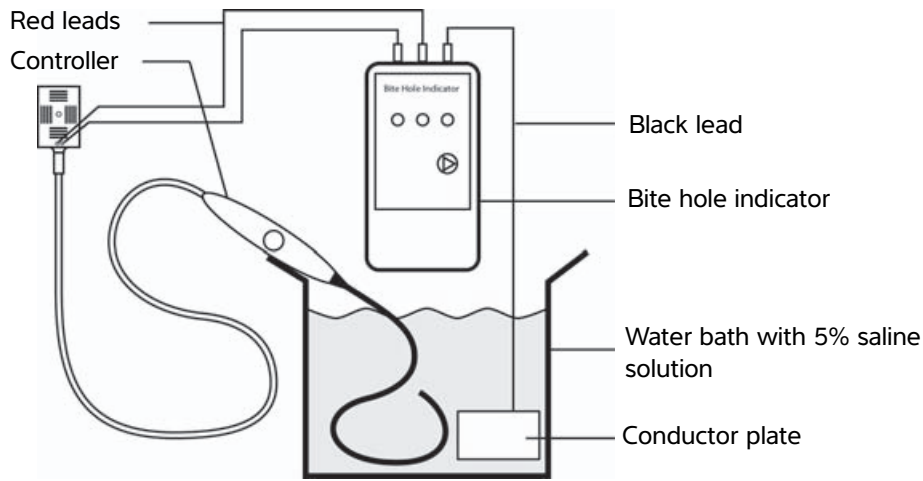

Figure 5-3 Transducer array test setup

- 1 After securing the controller so it does not fall into the water bath, immerse the scan head and endoscopic shaft in liquid to above the 40 cm mark, but below the 90 cm mark.

**WARNING:** Do not immerse the controller, cable, or connector in any fluid.

**Caution:** Do not allow the endoscopic shaft to contact the conductor plate. Doing so could result in an inaccurate test result.

- 2 Connect the Bite hole indicator to the transducer connector and the conductor plate:

- a Connect the black lead to the conductor plate in the salt-water bath as shown in [Figure 5-4](#) on page 5-8.

**Note:** Use the lead attached to the conductor plate. Do not submerge the indicator clip.

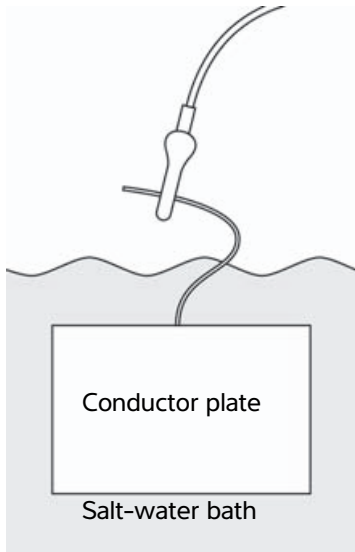

Figure 5-4 Conductor plate attachment

- b** Connect the red leads to the knurled socket cap screws on the transducer connector as shown in **Figure 5-5**.

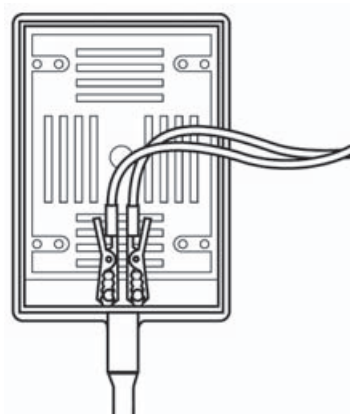



Figure 5-5 Transducer connector attachment

**3** On the Bite hole indicator, press 

**4** Read the test result:

- ▶ **Leads** - The leads are not connected correctly. Check the connections, and test again.

- ▶ **Fail** - There was a bite hole detected in the transducer array. Stop the bite hole test procedure. Do not use the transducer. For remediation steps, see **"If the transducer fails the test"** on page 5-11.
- ▶ **Pass** - No bite holes were found.
- ▶ **All** - If all of the lights are illuminated, the battery is low. Replace the battery.

## Testing the endoscopic shaft

### To test the endoscopic shaft for bite holes or current leakage

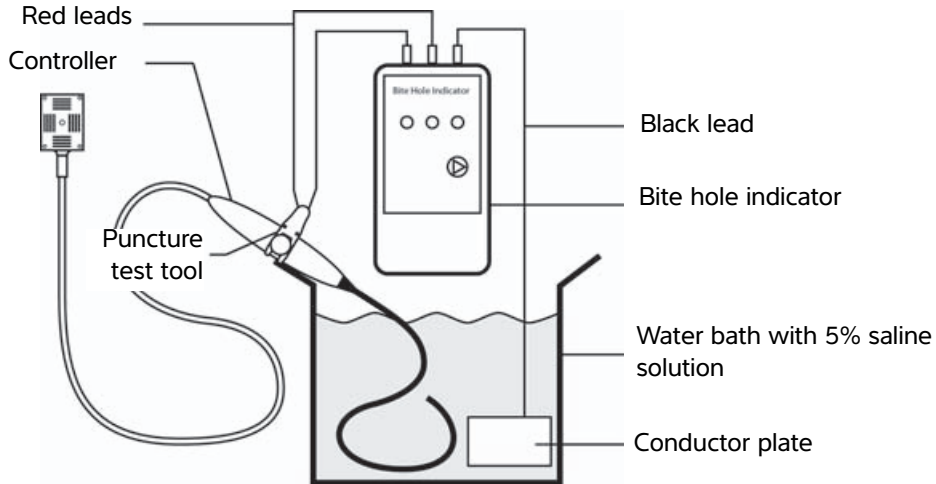

Figure 5-6 Endoscopic shaft test setup

- 1 Insert the puncture test tool under the scan plane controller as shown in **Figure 5-7**. The puncture test tool is included with the TEExi transducer.

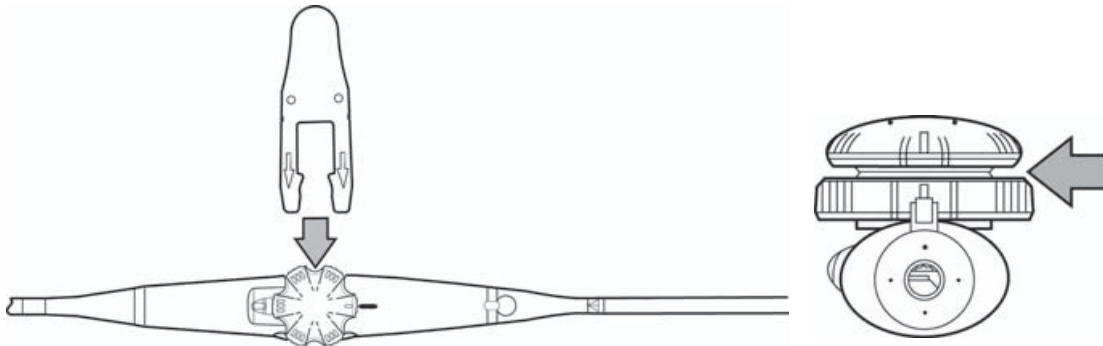

Figure 5-7 Insertion of the puncture test tool.

- 2 Immerse the scan head and endoscopic shaft in liquid to above the 40 cm mark, but below the 90 cm mark.

**WARNING:** Do not immerse the controller, the cord, or the connector in any fluid.

**Caution:** Do not allow the endoscopic shaft to contact the conductor plate. Doing so could result in an inaccurate test result.

- 3 Connect the Bite hole indicator to the puncture test tool and the conductor plate:

- a Connect the black lead to the conductor plate in the salt-water bath as shown in [Figure 5-8](#).

**Note:** Use the lead attached to the conductor plate. Do not submerge the indicator clip.

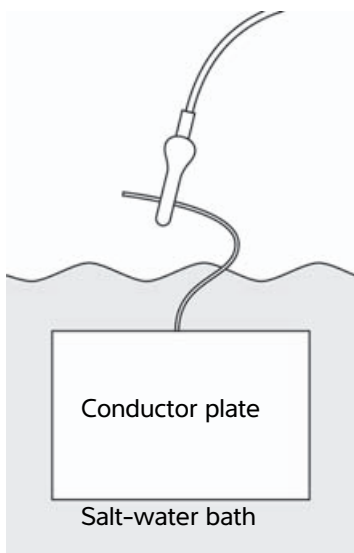

Figure 5-8 Conductor plate attachment

- b Connect the red leads to the puncture test tool as shown in [Figure 5-9](#) on page 5-11.

**Note:** Each clip should be attached separately to the puncture test tool.

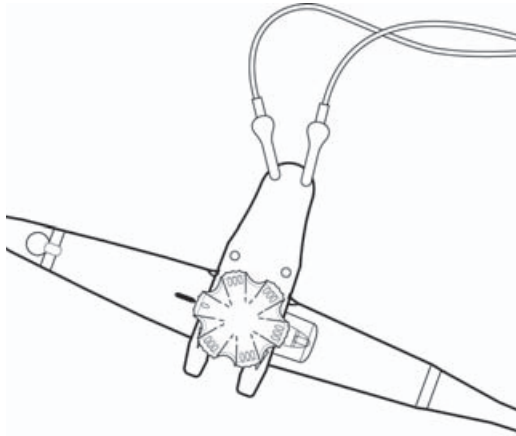

Figure 5-9 Puncture test tool attachment

4 Press 

5 Read the test result:

- ▶ **Leads** - The leads are not connected correctly. Check the connections, and test again.
- ▶ **Fail** - There was a bite hole detected in the endoscopic shaft. Stop the bite hole test procedure. Do not use the transducer. For remediation steps, see **“If the transducer fails the test”** on page 5-11.
- ▶ **Pass** - No bite holes were found.
- ▶ **All** - If all of the lights are illuminated, the battery is low. Replace the battery.

6 After the test, rinse the endoscopic shaft for one minute with a large volume of clean, lukewarm water to remove residual saline solution (for example, eight liters).

7 Dry the endoscopic shaft with a clean, non-linting towel.

### **If no bite holes are detected**

To identify the transducer as safe, you should include a sticker or certificate that travels with the transducer that includes the date of the test, the name or other identification of the tester, and the outcome of the test. If the bite hole test was performed as part of the cleaning process, continue to clean and disinfect the transducer.

### **If the transducer fails the test**

Do not use the transducer. Do not connect the transducer to an ultrasound system. Contact FUJIFILM SonoSite for repair.

To identify the transducer as unsafe to use, you should include a sticker or certificate that travels with the transducer that includes the date of the test, the name or other identification of the tester, and the outcome of the test.

## Transducer temperature rise

**Table 5-3: Transducer surface temperature rise, internal use**

Test	TEExi
Still air	8.6
Simulated use	4.7 ( $\leq 6^{\circ}\text{C}$ )

## Output display

**Table 5-4: TI or MI  $\geq 1.0$**

Transducer Model	Index	2D/M Mode	CPD/ Color	PW Doppler	CW Doppler
TEExi	MI	No	No	No	No
	TIC, TIB, or TIS	No	No	Yes	Yes

## Acoustic output

**Table 5-5: Transducer Model: TEExi Operating Mode: PW Doppler**

Index Label			M.I.	TIS			TIB	TIC
				Scan	Non-scan		Non-scan	
					$A_{aprt} \leq 1$	$A_{aprt} > 1$		
Global Maximum Index Value			(a)	-	(a)	-	1.4	(b)
Associated Acoustic Parameter	$p_{r.3}$	(MPa)	#					
	$W_0$	(mW)		-	#		35.8	#
	min of $W_{.3}(z_1), I_{TA.3}(z_1)$	(mW)				-		
	$z_1$	(cm)				-		
	$z_{bp}$	(cm)				-		
	$z_{sp}$	(cm)					2.57	
	$z@PII_{.3max}$	(cm)	#					
	$d_{eq}(z_{sp})$	(cm)					0.29	
	$f_c$	(MHz)	#	-	#	-	3.81	#
Dim of $A_{aprt}$	X (cm)		-	#	-	0.90	#	
	Y (cm)		-	#	-	0.90	#	
Other Information	PD	( $\mu$ sec)	#					
	PRF	(Hz)	#					
	$p_r@PII_{max}$	(MPa)	#					
	$d_{eq}@PII_{max}$	(cm)					0.28	
	Focal Length	$FL_x$ (cm)		-	#	-		#
		$FL_y$ (cm)		-	#	-		#
$I_{PA.3}@MI_{max}$	( $W/cm^2$ )	#						
Operating Control Conditions	Control 1: Exam Type						Card	
	Control 2: Sample Volume Size						1mm	
	Control 3: Sample Volume Position						Zone 3	
	Control 4: PRF						2604	

(a) This index is not required for this operating mode; value is <1.

(b) This transducer is not intended for transcranial or neonatal cephalic uses.

# No data are reported for this operating condition since the global maximum index value is not reported for the reason listed. (Reference Global Maximum Index Value line.)

- Data are not applicable for this transducer/mode.

**Table 5-6: Transducer Model: TEExi Operating Mode: CW Doppler**

Index Label		M.I.	TIS				TIB	TIC
			Scan	Non-scan		Non-scan		
				$A_{aprt} \leq 1$	$A_{aprt} > 1$			
Global Maximum	Index Value	(a)	-	(a)	-	1.7	(b)	
Associated Acoustic Parameter	$p_{r,3}$ (MPa)	#						
	$W_0$ (mW)		-	#		34.4	#	
	min of $W_{.3}(z_1), I_{TA.3}(z_1)$ (mW)				-			
	$z_1$ (cm)				-			
	$z_{bp}$ (cm)				-			
	$z_{sp}$ (cm)					1.1		
	$z@PII_{.3max}$ (cm)	#						
	$d_{eq}(z_{sp})$ (cm)					0.34		
	$f_c$ (MHz)	#	-	#	-	4.00	#	
	Dim of $A_{aprt}$	X (cm)		-	#	-	0.43	#
	Y (cm)		-	#	-	0.90	#	
Other Information	PD ( $\mu$ sec)	#						
	PRF (Hz)	#						
	$p_r@PII_{max}$ (MPa)	#						
	$d_{eq}@PII_{max}$ (cm)					0.34		
	Focal Length	$FL_x$ (cm)		-	#	-		#
		$FL_y$ (cm)		-	#	-		#
	$I_{PA.3}@MI_{max}$ ( $W/cm^2$ )	#						
Operating Control Conditions	Control 1: Exam Type					Card		
	Control 2: Sample Volume					Zone 2		
	Control 3:							
	Control 4:							

(a) This index is not required for this operating mode; value is < 1.  
 (b) This transducer is not intended for transcranial or neonatal cephalic uses.  
 # No data are reported for this operating condition since the global maximum index value is not reported for the reason listed. (Reference Global Maximum Index Value line.)  
 - Data are not applicable for this transducer/mode.



# CHAPTER 6

## Transducer Specifications

### TEExi/8-3 MHz transducer

<b>Endoscopic shaft</b>	External Diameter: 10.5 mm Length: 110 cm
<b>Steering orientation</b>	Clockwise rotation of the lower deflection control wheel will deflect the tip anterior. Counterclockwise rotation of the lower deflection wheel will deflect the tip posterior. Clockwise rotation of the upper deflection control wheel will deflect the tip to the right. Counterclockwise rotation of the upper deflection wheel will deflect the tip to the left.
<b>Maximum deflection</b>	Anterior: 120° minimum, 130° maximum Posterior: 40° minimum, 60° maximum Right and Left: 40° minimum, 60° maximum
<b>Scan plane rotation</b>	The transducer scans images in any plane within a 180° (nominal) cone from a transverse plane, through the longitudinal plane and ending at the mirror of the first transverse plane. The scan plane rotation is motor-driven, with speed and direction selected with buttons on the endoscope handle. Maximum speed: 180° in approximately 5 seconds.
<b>Scan Angle</b>	90° maximum
<b>Transducer tip dimensions</b>	Length: 35 mm* Cross-section maximum: 14 mm x 12.5 mm
<b>Disinfection classification</b>	Spaulding class, semi-critical
<b>Electrical Safety</b>	Conforms to applicable UL, CSA, IEC requirements for class BF.
<b>Temperature accuracy</b>	±0.5° C within the range of 35° to 45° C

<b>Transducer tip temperature limits</b>	Upper: 42.5° C Lower: 17.5° C
<b>Transducer</b>	Center Frequency 5.0 MHz
<b>Cable length</b>	2 m
<b>Biocompatibility</b>	All patient contact materials of the TEExi transducer/endoscope system comply with ISO 10993-1. The transducer is latex free.
<b>Environmental limits (shipping and storage)</b>	Temperature: Shipping: -35° to +65° C Storage: 0° to +45° C Humidity: 15 to 95% R.H. Pressure: 700 to 1060 hPA (0.7 - 1.05 ATM)

\* Defined as the length of the inflexible distal part of the transducer.



**FUJIFILM**  
Value from Innovation

**SonoSite**

P21458-02

